



Compact PowerTraxx Powered Track Chair

FERNO/MAN/0325/227-R3/UK
Stock Code 2003-0160



*Read this Manual
and Retain for
Future Reference*

Ferno UK Customer Services

Customer Service and product support are important aspects of each Ferno product. Please have the product serial number available when calling, and include it in all written communications.

Telephone - Main Reception	+44 (0) 1274 851999
Telephone - Sales Department	+44 (0) 1274 854510
Telephone - Service Department	+44 (0) 1274 854511
Email - Sales	sales.uk@ferno.com
Email - Service	services.uk@ferno.com
Web	www.ferno.com/uk

Ferno (UK) Ltd, Ferno House, Stubs Beck Lane, Cleckheaton, West Yorkshire, BD19 4TZ

ALL OTHER LOCATIONS

For assistance or information, please contact your Ferno distributor. If you do not have a Ferno distributor, please contact your nearest Ferno Customer Services office.

USA HEADQUARTERS

Ferno-Washington, Inc., 70 Weil Way
Wilmington, Ohio 45177-9371, U.S.A.

Telephone	Country Code +1.937.382.1451
Fax	Country Code +1.937.382.6569
Internet	www.ferno.com

Disclaimer

This manual contains general instructions for the use, operation and care of this product. The instructions are not all-inclusive. Safe and proper use of this product is solely at the discretion of the user. Safety information is included as a service to the user. All other safety measures taken by the user should be within and under consideration of applicable regulations. It is recommended that training on the proper use of this product be provided before using this product in an actual situation.

Retain this manual for future reference. Include it with the product in the event of transfer to new users. Additional free copies are available upon request from Ferno Customer Service.

Proprietary Notice

The information disclosed in this manual is the property of Ferno (UK) Ltd., who reserve all patent rights, proprietary design rights, manufacturing rights, reproduction use rights, and sales use rights thereto, and to any article disclosed therein except to the extent those rights are expressly granted to others or where not applicable to supplier proprietary parts.

Limited Warranty Statement

The products sold by Ferno (UK) Ltd. are covered by a limited warranty. The complete terms and conditions of the limited warranty, and the limitations of liability and disclaimers, are also available upon request by calling Ferno (UK) Ltd. on +44 (0) 1274 851999.

© Copyright Ferno UK Ltd. All Rights Reserved.



Chair/Track Serial Numbers: _____

Location: CHAIR :- H-FRAME CROSS BRACE
TRACK :- ON SIDE OF TRACK BY MOTOR

EC	REP	FERNO S.r.l. via B. Zallone, n. 26, 40066 Pieve di Cento, Bologna, Italy +39.051.6860028
----	-----	---



UK	REP	Ferno (UK) Ltd. Ferno House, Stubs Beck Lane Cleckheaton, West Yorkshire, BD19 4TZ +44 (0) 1274 851999
----	-----	---



USER MANUAL

To request additional free user manuals, contact Ferno Customer Service, your Ferno distributor, or visit www.ferno.com/uk.

TABLE OF CONTENTS

Section	Page	Section	Page
1 - Safety Information	4	8 - Using the Chair to Transfer a Patient	25
1.1 Warning notices	4	8.1 Before Placing the Chair in Service	25
1.2 Important notices	4	8.2 General Guidelines for Use	25
1.3 Caution notices	4	8.3 Before using the Chair	26
1.4 Safety and Instruction Labels	5	8.4 Using the Chair to Move on Level Ground	26
1.5 Symbol Glossary	5	8.5 Moving Chair DOWN Stairs using Powered Track	27
2 - Operator Skills and Training	6	8.6 Moving Chair UP Stairs using Powered Track	29
2.1 Skills	6	8.7 Using Track Module navigate narrow landings	30
2.2 Training	6	8.8 Chair positioning on the Stairway	30
3 - About the Chair	7	8.9 Using Powered Track to give more landing space	30
3.1 General Specifications	7	8.10 Carrying the Chair DOWN stairs (without track)	31
4 - Operating the Chair	8	8.11 Carrying the Chair UP stairs (without track)	31
4.1 Unfolding the Chair	8	8.12 Using the Chair with the Storage Bracket	32
4.2 Folding the Chair	9	9 - Maintenance	33
4.3 Attaching the Powered Track Module	10	9.1 Maintenance Schedule	33
4.4 Deploying the Track for Use	11	9.2 Cleaning & Disinfecting the Patient Straps	33
4.5 Stowing the Track	11	9.3 Cleaning & Disinfecting the Chair & Track	33
4.6 Removing the Powered Track Module	12	9.4 Changing Control Unit Batteries	34
4.7 Adjusting Upper Handle Height	13	9.5 Auxiliary Cable Connection (re-pair/no battery)	35
4.8 Using the Patient Straps	14	9.6 Inspecting the Chair Frame	36
5 - Powered Track Module Features	15	9.7 Lubricating the Chair Frame	36
5.1 Powered Track Overview	15-16	10 - Parts and Service	37
5.2 Control Unit Overview	17	10.1 UK	37
5.3 Motor Power On/Off Button	18	10.2 Worldwide	37
5.4 Ascent and Descent Buttons	18	11 - Servicing Schedule	39
5.5 Motor Brake disable Button	19		
5.6 Lights On/Off Button	19		
5.7 Safety Speed Limiter Feature (SSL)	19		
5.8 Selecting Max Speed Setting	19		
6 - Battery & Battery Charger	20		
6.1 Milwaukee Battery Overview	20		
6.2 Attaching & Removing the Battery	21		
6.3 Battery Level Warning Indicators	22		
6.4 Battery Charger	22		
7 - Powered Track Deployment	23		
7.1 Powered Track module overview	23		
7.2 Opening the Track Module for Use	23		
7.3 Closing the Track Module to Stow	23		

1 - SAFETY INFORMATION

1.1 Warning Notices

Warning notices indicate a potentially hazardous situation which, if not avoided, could result in injury or death.

 WARNING
Improper use of the chair can cause injury. Use the chair only for the purpose described in this manual.
Untrained operators can cause injury or be injured. Permit only trained personnel to operate the chair.
Improper operation can cause injury. Operate the chair only as described in this manual.
An unattended patient can be injured. Stay with the patient at all times.
An unrestrained patient can fall off the chair and be injured. Use restraints to secure the patient on the chair.
Helpers can cause injury or be injured. Maintain control of the chair, whilst directing all helpers.
Improper maintenance can cause injury. Maintain the chair only as described in this manual.
Non Ferno parts and service can cause injury. Use only Ferno parts and Ferno approved service on the chair.
Modifying the chair can cause injury and damage. Use the chair only as designed by Ferno.
Attaching Non Ferno items to the chair can cause injury. Use only Ferno approved items on the chair.

 WARNING
It is recommended NOT to carry occupant with the rear handle FULLY EXTENDED

1.2 Important Notices

Blood borne Disease Notice

To reduce the risk of exposure to blood borne diseases such as HIV-1 and hepatitis when using the chair, follow the disinfecting and cleaning instructions in this manual.

1.3 Caution Notices

Bleach, phenols and iodine can cause damage. Do not apply products containing these chemicals to the Chair.

Improper lubricants can cause damage. Use a liquid lubricant oil such as "3-IN-ONE Multi-purpose drip oil" to lubricate the Chair where specified.

Trapping hazards are unavoidable in the design of this equipment due to its folding action. Operate the folding mechanism with care.

 WARNING
Do NOT exceed the safe working load of 200 kg

1.4 Safety & Instruction Labels

Safety and instruction labels place important information from the users' manual on the Chair.

Read and follow label instructions. Replace worn or damaged labels immediately. Replacement labels are available from Ferno UK.

1.5 Symbol Glossary

The symbols defined to the right are used on the Chair and/or in this users' manual. Ferno uses symbols recognised by the International Standards Organisation (ISO).



Do Not Lubricate



Safe Working Load



Product meets UK and EU Standards



Wheeling Chair no track attached



Chair with Track attached

2 - OPERATOR SKILLS AND TRAINING

2.0 Skills

Operators using the chair need:

- The strength, balance, coordination and common sense to safely operate the Chair.
- The ability to select the proper equipment and procedures for the circumstances.
- Operators should have been trained in the operation of the Chair.
- The ability to understand and follow the procedures described in this manual.
- Operators should have a working knowledge of manual handling procedures.

2.1 Training

Operator trainees need to:

- Have followed a training plan.
- Read and understand the instructions in this manual.
- Practice using the fully-equipped Chair with weight and under simulated conditions.
- Trainees should be tested to verify their understanding of Chair operation.
- Keep training records. Annual refresher training for all Chair operators is recommended.



WARNING

**Untrained operators can cause injury or be injured.
Permit only trained personnel to operate the Chair.**

3 - ABOUT THE CHAIR



Chair with Track detached

CHAIR FEATURES

- Chair folds to minimise stowage space.
- Powered Track module can be attached for ascending descending stairs, moving over kerbs, up ramps and inclines, etc.
- Adjustable-height handle to enable correct posture for operator when wheeling and when using as a track chair
- Control box attached to upper handle for control of powered track module
- Control box can be rotated on handle to allow best positioning for operator
- Anti-Bacterial properties within patient straps, Grip Tape, Seat Cover, Powder coat and Head pad materials.
- CEN compliant In-vehicle storage bracket available.
- Compact PowerTraxx p/n 071481801
- In-vehicle storage bracket for Compact PowerTraxx p/n 009103900

3.1 General Specifications

Most general specifications below are rounded to the nearest whole number. For more information, contact Ferno Customer Service Department (page 2).

Ferno reserves the right to change specifications without notice.

The Compact PowerTraxx is powered track chair, which can be used as a standard carry chair but with the capability of attaching a powered track module to assist in the descent and ascent of stairs, kerbs, inclines etc.

Chair height folded (without track attached)	850 mm
Chair height	1102 mm
Height with rear handle extended	1485 mm
Seat height	485 mm
Chair width	450 mm
Chair depth folded (without track)	290 mm
Track assembly length	720 mm
Track assembly width	340 mm
Track assembly depth	120 mm
Weight of carry chair	13.3 kg
Weight of track	9.0 kg
Weight of battery	1.0 kg
Total weight of chair incl. Track and battery	23.3 kg
SWL / Max load capacity	200 kg
Strap type	Biosafe
Strap length – Chest	1650 mm
Strap length – Leg	1200 mm

WARNING

Improper use of the Chair can cause injury. Use the Chair only for the purpose described in this manual.

4 - OPERATING THE CHAIR

4.1 Unfolding the Chair

The chair can be folded for stowage only when the Powered Track module is not attached. To unfold the chair,

1. Undo the chest strap (if used to stow the chair), then unfold by placing the Chair on the ground and pulling the rear handle from the lower handle.



Unfolding the Chair for use

2. Completely unfold by firmly pushing up the back until an audible click is heard and physically check that the opened chair has locked out in place.



Lifting up back rest whilst applying force to the foot rest

3. Once the chair is locked secure, move both of the safety rings down over the hinge bracket as per the photo.

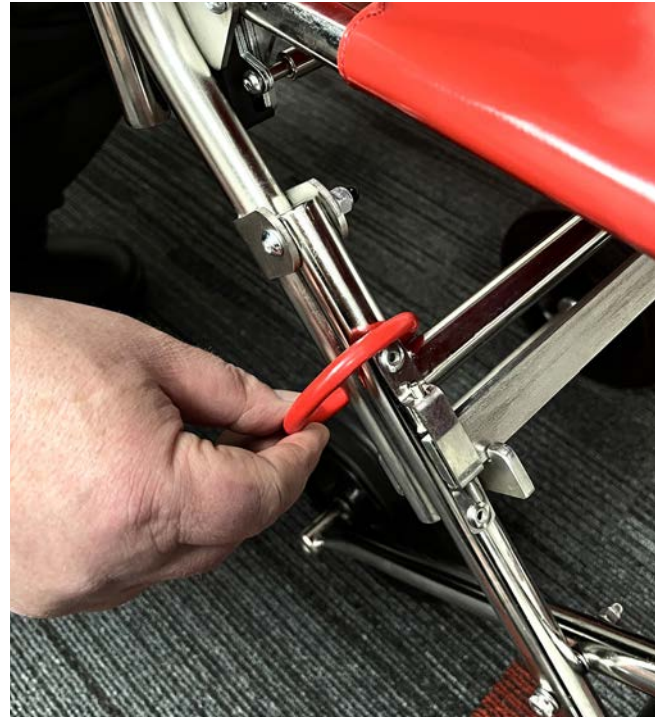

Securing the chair by deploying safety rings



Chair deployed and ready for use without Track

4.2 Folding the Chair

Before folding, fully lower the height-adjustable handle if it is raised (see 'Adjusting Upper Handle Height') and remove the powered track module if it is attached (see 'Removing the Track').

1. Push the Safety Rings up over each hinge bracket



Removing safety rings so Chair can fold

2. From behind the Chair, release the locking bar (in the centre of the chair frame) by lifting the bar towards you, either by hand or foot and carefully fold the Chair forwards.



Release the locking bar to allow Chair to fold

3. Push in a downward direction on the upper handle to fold the lower handle upwards in reaction to the downward force.



Folding the Chair ready for stowage

4. The chest strap can be used to secure the Chair in the folded position.



Chair folded and fastened secure for stowage

4.3 Attaching Powered Track Module

The chair features an attachable Powered Track Module to aid ascending or descending stairways, moving up/down curbs, up inclines/ramps and even in and out of a vehicle via the rear or side steps (dependant on individual local vehicle protocols)

Before attempting to attach the powered track to the chair, ensure that the locking latches on the back of the chair are open to allow the track module to be attached onto the chair. If they are not open, then pull down on the RED Track release bar down to open them (as shown in photo on page 12, Removing Track) and then commence the procedure for attaching the Track module.



Ensure that the locks on back of chair are open

1. Lay the Track module on the floor behind the chair and position yourself with legs straddling either side of the track module as per the photo below. Lift the Chair slightly and drop into place such that the chair axle bar locates into the lower lock on the Track module.
2. Push the Chair axle securely into the lower lock until it clicks and is securely locked in place.
3. Lift and rotate the Track module upwards and towards the locking latches on the back of the chair frame.



Track attached on axle



Bring the track up towards the back of the chair to lock in place



Push track towards chair to close the push-to-close latches and attach the track to the frame

4.4 Deploying the Track for Use

Once the Track module is attached to the chair, it can be unfolded and deployed for use.

Whilst holding the Chair securely from the rear, pull the red 'Pull to Open' bar towards you and down, until the Track module locks out into position (aided by the attached gas strut).



Pulling Track out for use



Chair with Track deployed ready for use

4.5 Stowing the Track

The track module can be stowed away at any time out of the way when not in use to give more space for manoeuvring, for example around stair landings etc.

1. To fold the track into the back of the chair, holding the chair with one hand, push the bar with RED 'Push to Close' label downwards as shown in photo below, until the track is flush with the back of the chair and stays in position. Note that when in the stowed position, the track should remain in the upright position and should not drop back down. If the track bracket mechanism is found to be loose such that the track is not staying upright then the chair should be taken out of service and the holding gas strut replaced.



Using 'Push to Close' bar to stow Track

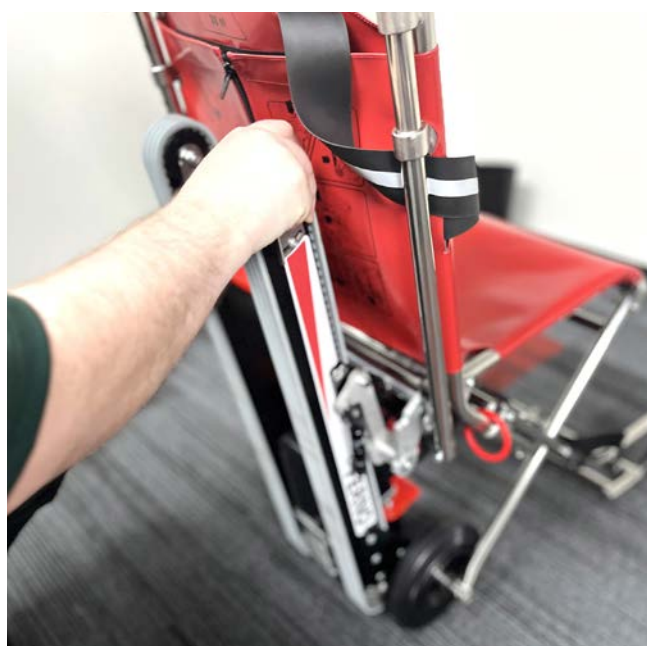

Track stowed

4.6 Removing the Track Module

Prior to folding the chair for storage the Powered Track module must first be removed from the chair.

Procedure should be carried out only after having transferred the patient off the Chair.

1. Whilst holding the track with one hand, using one or two fingers positioned above the rotating RED track release bar below the chair seat at the back, pull the release bar downwards and this will open the locking latches on the back of the chair and release the track bracket locating pins from the two push-to-close latches, detaching the Track from the back of the Chair.



Releasing Track from push-to-close latches

2. Keeping hold of the track, bring the track module GENTLY down to the floor, whilst still attached to the chair at the axle. Do NOT let the track module drop down onto the floor as this may damage the electronics inside over time.



3. With the Track module laid on the ground still attached to the chair axle, straddle the track behind the chair bring your foot in under the chair and using your heel of your foot, pull back on the RED release handle on the Track module to disengage the axle locking mechanism and then lift the Chair out of the axle locking mechanism.



Releasing the Track from the Chair using the heel of your boot

4. An alternative method to detach the track from the chair axle is to pull back the RED release handle with your hand.

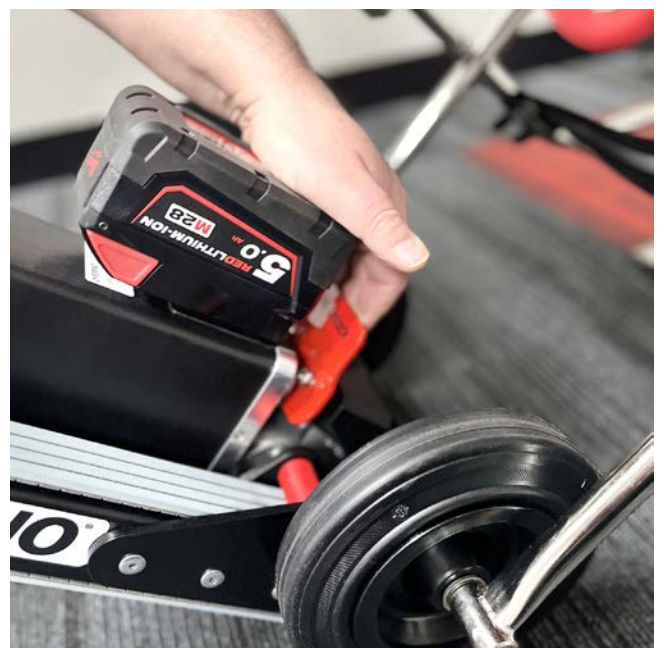

Releasing the Track from the Chair using hands

4.7 Adjusting Upper Handle Height

The upper handle of the Chair can be adjusted to different positions for when used as a Track Chair and when used as a Carry Chair.

1. To adjust the handle position, with one hand pull out the index pin whilst with the other hand pull the handle up until the required position is reached then release the index pin to lock in place. Ensure that the handle has correctly locked in place by visually looking at the locking pin and by slightly moving the handle up and down.



Chair height adjustment index pin

2. When using as a Track Chair it is recommended to raise the rear handle to the highest position for best posture on the stairs, as per below picture. However when manoeuvring around tight stairway landings, it might be necessary to lower the handle one position to give more space.

3. When using as a carry chair for wheeling a patient the upper handle can be adjusted to position 1, 2 or 3 to optimise posture of operators. It is NOT recommended to use position 4 when using as a Carry Chair.

If having to revert to lifting a patient on the chair where the powered track module cannot be used, it is recommended to always have the handle as low as possible to ensure maximum stability when lifting. The closer to the chair and patient that the operator is positioned, the better control the operator has, minimising the risk of side tipping

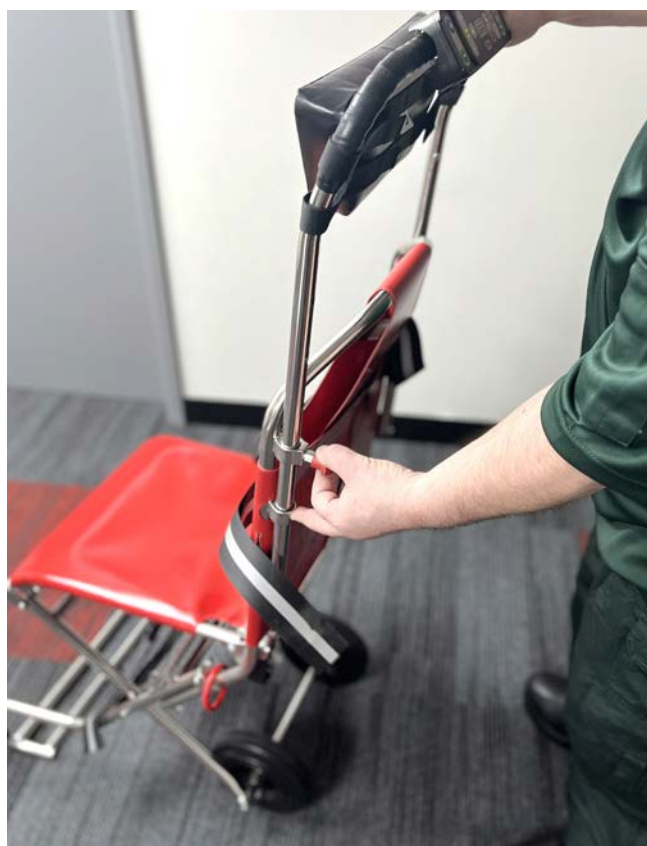

Adjustable handle heights

WARNING

Only fully raise the handle when using the Chair to descend stairs with the Track deployed.

4.8 Using the Patient Straps

Use the chest and foot straps to secure the patient into the Chair. Assess the patient condition to determine optimum strapping procedure.

- Chest strap: First fasten the chest strap, using the plastic male/female buckle system. Pull the loose free ends of the strap to tighten the strap.

If not blanketed, it is recommended that the chest strap is deployed with the patient's arms in under the straps as per the photo, this ensuring that the patient cannot reach out and grab the bannister or other, when moving up or down set of stairs or elsewhere.

The chest strap can also be used to secure the chair closed for stowage.

- Releasing patient straps: To release the foot and chest straps, squeeze the two sides of the tang on the buckle inwards at the same time to pull the buckle apart.

Ensure to unbuckle the foot strap first, then the chest strap, thereby avoiding the patient from standing up and tripping over when trying to move if chest strap is loosened first before the foot strap has been loosened.



Chest strap buckle click-in and pull to tighten



Full recommended harness configuration

- Foot strap: Once the patient's feet are comfortably placed on the integral footrest, the foot strap must be applied to secure the feet in place and avoid their feet slipping off the footbar when moving the patient. Fasten the foot strap using plastic male/female buckle system. Pull the loose free ends of the strap to tighten the strap. Remember that the foot strap also protects the operator when moving the Chair on stairs by stopping the patient from kicking out.

5 - POWERED TRACK MODULE FEATURES

5.1 Powered Track Overview

- Motorised system for ascending and descending stairs
- Rechargeable 28V lithium-ion motor battery
- Battery charger
 - 220-240 VAC, 50/60 Hz (Europe); CE certificate
- 1.5V AA alkaline batteries powering the control box
- Auxiliary connection cable
- Lighting system



Powered Track Module



Main battery



Lighting system



Battery charger 240v AV



Motorised system components



Auxiliary connection cable

5.1 Powered Track Overview (cont...)

The Powered Track module includes a motor, battery, and track belt drive system, which when the Track module is attached to the chair allows a patient to be moved up or down stairs, inclines, etc. under the power of the motor but under the control of the operators, thereby reducing the amount of manual handling effort that the operators need to exert to move a patient.

CONTROL UNIT: The control unit is mounted on the extendable-height handle. It allows the operator to control the speed and movement of the tracks, monitor the battery charge level, turn light on and off, and operate other functions of the chair.



Control unit

UP/DOWN CONTROLS: The up/down controls are positioned on both sides of the control unit and are easily accessible and identifiable using the corresponding symbols to enable correct usage by the operator. +/-

"+" for moving upstairs and "-" for moving downstairs.

The track movement can be controlled by variable speed or fixed speed controls, the variable speed control buttons located on the RHS of the control box, the fixed speed controls on the LHS.

For the variable speed control, the pressure with which the buttons are pressed determines the speed of the chair, allowing the operator to gradually alter the speed whilst moving up or down the stairs.

MOTOR POWER ON/OFF BUTTON: The power on/off button is located on the motor housing and allows to switch the track motor on and off. The control box powers up when any button is pressed and automatically switches itself off around 5 seconds after the motor power is turned off.

LIGHT BUTTON: The track module is equipped with a set of lights, which when turned on illuminates the surrounding area, especially useful in poorly-lit stairways. The light on/off button is located on the control unit and allows operator to switch the lights on and off as and when required.

MOTOR: The motor is located at the rear of the chair and it controls the tracks' movement. The motor receives inputs from the control unit to adjust the speed and movement (direction) of tracks.

TRACKS: The tracks allow the device to ascend and descend stairs. They are driven by the motor. The operator controls the speed and movement (direction) of the tracks using the controls.

MOTOR BRAKE: The motor brake is automatically activated whenever the chair is switched on. This stops the track from moving when stationary on the stairway, and is automatically disengaged whenever the up or down control buttons are pressed.

MOTOR BRAKE OFF FUNCTION: The motor brake on/off button allows the motor brake to be manually disengaged, which then allows the chair to be brought down stairs manually not under power, similar to a manual track chair, which may be required in certain circumstances such as if the battery level becomes fully depleted when part way up or down a set of stairs.

MAIN BATTERY: Rechargeable Milwaukee M28V lithium-ion battery is mounted on the motor housing. The battery can be easily removed recharging by pressing the 2 red buttons on the sides of the battery and slide the battery off the holder.



Main Battery & Motor Housing

WARNING

Do not open the motor housing. Only Ferno's authorised and trained technicians can open and work on the motor housing

5.2 Control Unit Overview

The control unit has the following controls:

- **Ascent and descent buttons** - to control the tracks movement for ascending or descending stairs, indicated by the "+" and "-" symbol. Use the "+" button to ascend the stairs and "-" to descend.
- The speed of movement can also be varied using the +/- buttons on the right side of the control box which are variable speed control buttons, depending on the amount of pressure on the button exerted by the user will change the speed at which the chair will move. The controls on the left side however have no variable speed control function, so when the button is pressed the chair reaches its maximum speed independent of how hard the button is pressed. The "maximum" speed depends on whether "FAST" or "SLOW" speed mode has been selected.
- **Motor Brake Disable Button** - to enable or disable the motor brake. The motor brake function is always enabled by default and the brake is released whenever operator presses + or - button, thereby allowing the powered motor to run. The motor brake can be manually disabled using this button when requiring to move the chair down stairs not under power, for example when no battery charge remaining.
- **Light Button** - switches the lights on and off
- **Speed selection button** - allows to select the maximum speed required. Recommended to use SLOW when moving a patient. FAST mode can be used when moving the chair up or downstairs with the chair not occupied, or in emergency situation where it is necessary to get the patient up or down the stairs urgently and have risk assessed the stairway to ensure that it is safe to do so, i.e. on a wide straight stairway with no bends
- **Main battery indicator** - shows the charge status of the Milwaukee 28V battery attached to the motor unit
- **Controller battery indicator** - shows the charge status of the controller batteries. If the indicator light switches on, fit two new 1.5V AA batteries
- **Connection problems indicator** - lights up when no connection has been established between the controller and the motor unit

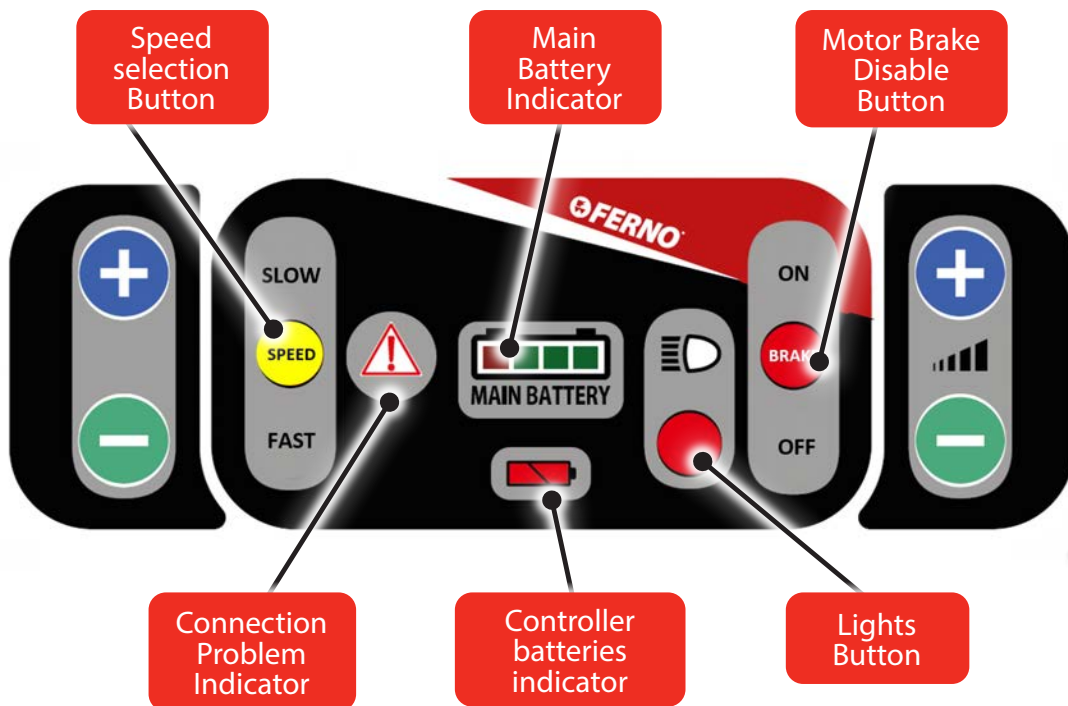

Control unit guide

5.3 Motor Power On/Off Button

The Power button, located on the motor housing, is used to switch on the chair. Depress the button to turn on the chair and press again to turn off. Always keep the motor switched off when the chair is not in use to preserve the battery charge and avoid any accidental activation of the movement system. When the motor is switched off the control box automatically switches itself off after a few seconds of time of inactivity.

SWITCHING ON

1. Depress the silver ON button on the top of the motor
2. Button light will turn blue
3. Press any button on the control box to connect the control unit to the motor (wireless connection)
4. It may take a few seconds to establish the wireless connection. When the link is active, the control unit emits an audible beep and the Power button light will change from blue to green and control unit buttons will illuminate. The chair is now ready for use.
5. To switch off the chair press the power button again
6. Before any operation with the chair, check the battery charge status. This is possible via the corresponding indicator light on the control unit or the battery indicator on the battery itself (see section 8.10 *Battery*).



Power Button

Important

For longer battery life, always switch off the chair when it is not in use.

Lithium-ion batteries have no memory effect. It is not necessary to fully discharge the battery before recharging.

5.4 Ascent and Descent Controls

The ascent and descent controls are identified by labels with the symbols "+" and "-".

The controls are located on the control unit fitted on the extendible carrying handle, so they are always within easy reach of the operators. The variable speed control buttons on the RHS of the controller are pressure sensitive and determines the speed of the tracks according to how hard the button is pressed, thereby allowing the operator to control the speed of the chair with greater precision. Conversely, the controls on the left-hand side of the controller are fixed-speed, bringing the chair to full speed with a pre-set acceleration ramp, independently of how much pressure is being used when pressing on the buttons.

To start the track movement, press the controls. Place your hands on the extendible carrying handle, so that at least one button is accessible to the thumb.

- **TO GO UP STAIRS:** Press the "+" symbol button.
- **TO GO DOWN STAIRS:** Press the "-" symbol button.

Alternative way to remember by colour:

- **GREEN Grass (down) BLUE Sky (up)**



Up and down controls

DESCENT



DOWN

ASCENT



UP

Up and down control symbols

5.5 Motor Brake Disable Button

The brake function prevents track movement when the controls are not being pressed such that when stationary on the stairs the track will not move. By default, the brake function is always active, as shown by the symbol ON that lights up on the control panel.

The operator can enable or disable this feature through the appropriate button on the control unit.

- **MOTOR BRAKE ENABLED:** Brake "ON" lights up on controller.
- **MOTOR BRAKE DISABLED:** Brake "OFF" lights up on controller.
- During the way up and / or down the stairs, when the operator releases the + or - button the brake will engage. The brake function helps hold the chair in position, thus greatly reducing the effort needed to hold the chair on the stairs at any time.

It is recommended to leave the brake function always activated in normal use in order to ensure safe transport of the patient.

If the chair is required to be moved down stairs not under power, then the brake can be disabled and the chair moved in the same way as a non-powered manual-track chair. Pay the utmost attention and control the chair when going down the stairs if the motor is not running and the brake function is disabled.

5.6 Lights On/Off Button

The Lights button switches the lights fitted on the motor on and off; the lights improve safety, illuminating the surroundings in which the chair is being used.

Press the button to switch on the lights; press again to switch them off.

5.7 Safety Speed Limiter SSL

The SSL function ("*Safety Speed Limiter*") trips automatically when the chair exceeds a predetermined safe speed limit on the way down the stairs. This ensures safely controlled descent during patient transport.

It also guarantees safe operation of the chair even when the battery is low or damaged, or the circuit board is not working properly for whatever reason. In case of a low battery, recharge the battery immediately.

5.8 Selecting Max Speed Setting

The chair has two speeds for going up and down the stairs.

To select the desired speed, proceed as follows:

1. Press the Speed selection yellow button to toggle to the speed required.
2. When the speed has been selected, the relative speed description label will light up (SLOW or FAST)
3. It is suggested to use SLOW mode in most cases. Fast speed should only be used when moving the chair up/down stairs with no patient on the chair or only with a patient on the chair in an emergency situation, where it is necessary to move the patient quickly from the stairs in order to carry out medical intervention
4. If moving a patient on the stairs in Fast speed mode in an emergency, it must only be used where the patient is less than 120 kg

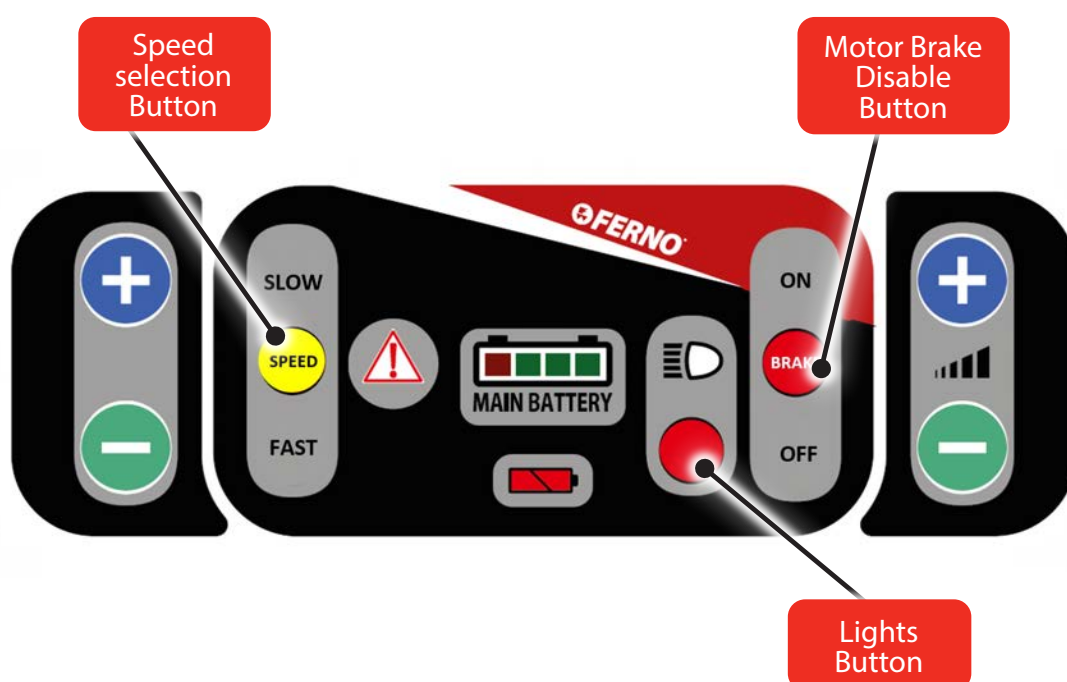

6 - BATTERY & BATTERY CHARGER

6.1 Milwaukee Battery Overview

The chair is equipped with a Milwaukee® 28 VDC Lithium-ion battery. The design ensures the battery is protected from dirt, body fluids, rain, etc.

Use only Milwaukee® batteries and chargers approved by Ferno.

BATTERY

- Lithium-ion batteries have no memory effect. It is not necessary to fully discharge the battery before recharging. It can be trickle charged at any time.
- Charging time less than 1 hour for a fully discharged battery. The charging time varies according to the charging frequency, the discharge level, and age of the battery. If the battery is fully discharged, the charging time will be longer.
- The range of operating temperatures recommended by the Manufacturer for the battery is between -10°C and +49°C. Battery capacity may be affected if it is stored for a long period at temperatures below -17°C or above 66°C.
- Dispose of the battery when it reaches the end of its working life. Do not dispose of the battery with household waste.

BATTERY USAGE

- The insertion slots on the battery are compatible with those of the Milwaukee charger, and with those of the battery holder on the chair. Refer to section *Inserting and removing the battery*, and section *Battery charger*.
- To remove the battery from the chair or the battery charger Press the two red buttons on each side of the battery and slide off the holder.
- To check the battery charge status, press the battery charge indicator button on the battery. Refer to subsection *Battery charge indicators*
- ONLY store the battery in a cool, dry environment. DO NOT store in an environment where the temperature exceeds 50°C.
- It is recommended to have two batteries, and keep the spare battery charged and ready for use.

Important

The battery capacity may be affected by the storage conditions if the chair is to be stored for an extended period at temperatures below -17°C or above 66°C.

Important

For longer battery life, always switch off the chair when it is not in use.

Lithium-ion batteries have no memory effect. It is not necessary to fully discharge the battery before recharging.



WARNING

Incorrect charging of the chair may cause damage and / or injury. Use only batteries approved and authorised by Ferno, and recharge only with chargers approved and authorised by Ferno.

Insertion slot

Release buttons

Battery



BATTERY CHARGE INDICATORS

The battery charge indicator has four LED lights which show the charge status of the battery (approx. 25% intervals) when the button on the battery is pressed.

Upon pressing the charge indicator button, the indicator lights showing the battery level will light up. If the battery is fully charged, all 4 LED indicators will light up, to 1 LED indicating 25% or lower. If the battery has a charge level below 10%, the first LED will blink four times upon pressing the button, indicating a depleted battery.

BATTERY SWITCH-OFF

The battery has a safety circuit which cause it to switch itself off if the internal temperature becomes too high in case of over-heating or ambient temperature too high. In this state pressing the button on the battery will cause the LEDs to light alternately. Wait for the battery to cool down before using. When the battery is ready for use, press the Battery button to check the charge level.

6.2 Attaching & Removing the Battery

Fitting the battery: Align the battery slots with the special supports on the chair. Insert the battery into the support until you hear an audible click. Ensure the battery is properly locked before using the chair.

Removing the battery: Fully press both red buttons on the sides of the battery (both left and right buttons), and extract the battery.

Important

In case of overheating, the battery switches off for protection purposes. Wait for the battery to cool before reusing use.



Battery charge level indicators



Battery holder on the track motor



Battery attached to motor

6.3 Battery Level Warning Indicators

MAIN BATTERY

The main battery charge can be checked in two ways:

- **Mode 1** = press the button on the battery to see its charge level.
- **Mode 2** = check the battery charge level on the controller by means of the specific indicator (see section "CONTROL UNIT")

CONTROL UNIT BATTERIES

The control unit is powered by two 1.5V AA batteries. If the  icon at the bottom centre of the control panel light up, this indicates the batteries are running low and should be replaced as soon as possible.

If the control unit's indicators do not light up, and the controls do not work, you may need to replace the batteries.



Double AA batteries

Important

The battery capacity can be affected by the conditions in which it is stored, such as storage for long periods in environments with temperatures below - 17°C or above 66°C.

6.4 Battery Charger

The Milwaukee battery and charger instructions replace those provided in this manual. For additional information, refer to the manuals of these components.

The chair is supplied with a battery charger.

- 220-240 VAC, 50/60 Hz (Europe)

Charging Time: approx. 1 hour. If the battery is completely discharged, the charging time may be longer. The charging time can vary based on the frequency of charging, the charge level of the battery and the battery's age.

Store the charger ONLY in a cool, dry environment. DO NOT store in environments with temperatures above 50°C.

INDICATOR LIGHTS

The charger has two lights (red and green), indicating:

- **RED (steady):** the battery is connected and charging.
- **GREEN (steady):** charging completed.
- **RED (flashing):** Overheating. Recharge the battery only when the temperature range is between 0°C and 65°C.
- **RED/GREEN (alternating flashing):** the battery is damaged or not functioning correctly. Replace the battery immediately.

CHARGING THE BATTERY

Fitting and charging the battery: Align the battery slots with the special supports on the battery charger. Insert the battery into the support until you hear an audible click. Make sure the battery is securely attached and that the indicator light on the charger turns on.

Removing the battery: Fully press both red buttons marked PRESS (both left and right buttons), and extract the battery.



Battery charger 240v AV

Also available is a 12v battery charger for use in-vehicle.

Both the 240v and 12v chargers can be wall mounted in vehicle-using dedicated wall brackets available from Ferno, which are crash tested and CEN compliant.

7 - POWERED TRACK DEPLOYMENT

7.1 Powered Track Module Overview

The Powered Track Module allows the chair to go up and down stairs/steps without having to lift or carry the chair and patient, as well as using as a power-assist when moving up an incline or ramp.

GENERAL GUIDELINES

- The use of the chair on stairs requires a minimum of two trained and qualified operators. If and where available Ferno recommends using a third person as a supervisor or spotter.
- Always make sure that the track is fully opened and locked out before use.
- Never lubricate the tracks. Lubricating the tracks can cause unpredictable device behaviour, causing damage and / or injury to the patient and / or operators.
- Moisture, water, snow, ice, or debris on and inside the track carriage can cause erratic operation and a sudden change in the weight to be supported by the operators. Ensure that the track carriage and the tracks are clean and dry before using the chair on stairs.
- Moisture, water, snow, ice, or debris on the stairs may affect the balance of the operators. To prevent possible damage and / or injury, clean the stairs or choose an alternative route.

7.2 Opening the Track for Use

- Hold the release bar (red) at the upper end of the track carriage and pull it out firmly until the track module locks out in fully open position.
- Try closing the track carriage to make sure that the locking system is engaged. If the locking system is correctly engaged, the carriage should not close.

7.3 Closing the Track to Stow

Push down the red closing lever in the middle of the track attachment bracket until the track carriage is fully closed and up against the back of the chair.

Note that the track module should always be stowed before attempting to detach the track from the chair for storing the chair and track in the vehicle.

WARNING

The use of the chair with an unlocked track carriage may cause damage and / or injury. Ensure the track carriage is properly locked before carrying the patient.

WARNING

Lubricating the tracks can cause damage and / or injury to the patient and / or operators. Never lubricate the track carriage or the tracks.

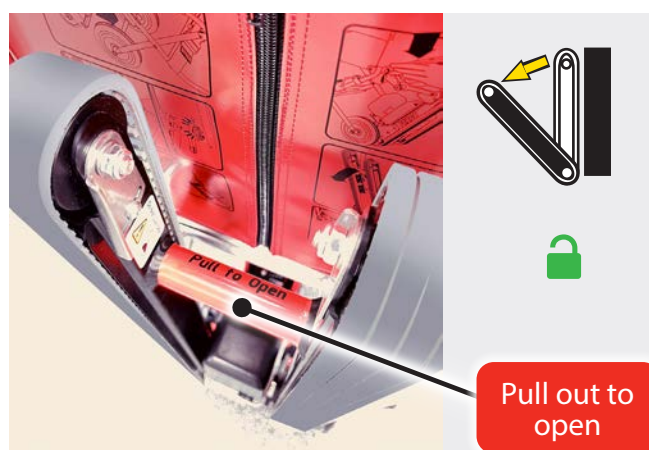

Open the track to deploy for use

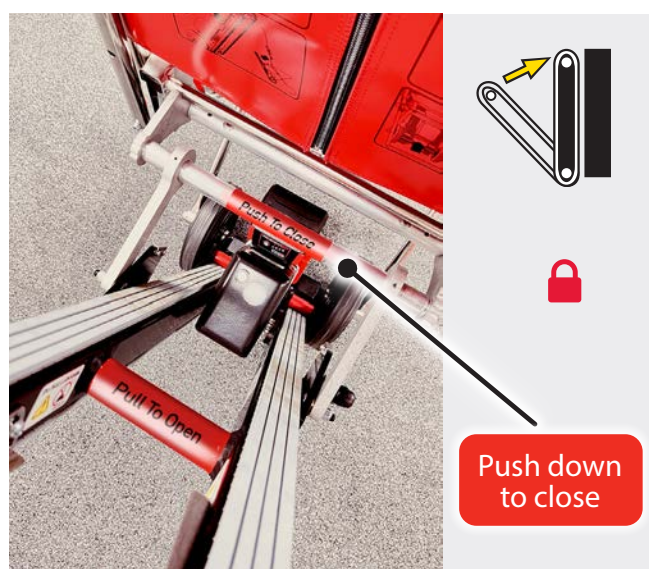

Close the track for storing when not in use

8 - USING THE CHAIR

8.1 Before Placing the Chair in Service

- Operators who will work with the Chair need to read and understand this manual and be trained on using the Chair.
- Set up the chair, following the instructions in '*Operating the Chair*'.
- Confirm that the Chair operates properly. See '*Inspecting the Chair*'.

8.2 General Guidelines for Use

- Requires two trained operators when the Chair is being used to transport a patient on stairs.
- Always inform the patient before a manoeuvre.
- One operator only can safely use the Chair as a wheeling carry chair to wheel a patient on flat surfaces with a second operator always on stand-by, but this must be at the discretion of the operator who must assess all likely conditions (also dependant on local protocols which may override this guideline.)
- One operator can safely load/unload a patient using the Chair to wheel a person from a vehicle fitted with a ramp, automatic tail-lift or other approved mechanical lifting mechanism, with second operator on stand-by at all times and available to help when needed.
- For all other uses of the chair and whenever using the powered track, two operators should always be used.
- Circumstance such as access, weather conditions or patient weight may require additional help when operating on stairs; this must be assessed at the time.
- Keep the load limit of the Chair in mind when working with a heavy patient. If it suspected that the load limit has been exceeded then a full inspection of the Chair should be conducted, preferably by Ferno Service Technician.
- Operators must take extra precautions when operating the Chair on uneven or soft ground.
- Extra precautions and risk assessment should be taken to prevent the Chair from slipping in adverse, wet or icy weather conditions.
- Stay with the patient at all times and always use the patient restraints provided.
- One operator should hold the chair at all times when the chair is occupied.
- If requiring to lift the chair and patient , always follow good lifting procedures as specified in current manual handling regulations and your appropriate training manual. However the powered track should always be used wherever possible to reduce the need to lift, including up/down curbs, single steps, inclines etc.
- Using the chair over rough or uneven ground, care must be taken to ensure the chair does not tip sideways when manoeuvring the patient . Use of the track in thee scenarios may not be of benefit. This should be risk assessed at the time.
- Follow standard emergency patient-handling procedures when operating the Chair.
- Medical advice is beyond the parameters of the manual. It is the user's responsibility to ensure safe practices for both themselves and the patient



WARNING

An unattended patient can be injured. Stay with the patient at all times



WARNING

An unrestrained patient can fall off the Chair and be injured. Use the chest and foot straps to secure the patient on the Chair at all times



WARNING

Improper use can cause injury. Use the Chair only for the purpose described in this manual

8.3 Before Using the Chair

- Transfer the patient on and off the Chair using local patient manual handling protocols.
- The Chair should be operated with 2 operators present at all times, both when used as a carry chair as well as when using as a powered track chair.
- Ensure that the patient is centrally seated with their back fully against the back rest before applying the patient chest and foot straps.
- Chest and foot straps must be applied before moving the Chair (See section 'Applying Patient Straps').

WARNING

Before positioning the patient on the Chair, always ensure the Chair is fully unfolded and that the safety rings are correctly positioned over each hinge bracket.

WARNING

Avoid rapid chair repositioning as this may result in patient injury. Always support the Chair while adjusting handles and deploying the track

WARNING

When moving patients always inform them of what you are going to do.

WARNING

Never leave a patient unattended in the Chair and always use restraints.

8.4 Using the Chair to Move on Level Ground

- Before wheeling the Chair on level ground, the head-end operator should adjust the upper handle to the desired position for comfortable use (See section 'Adjusting Upper Handle Height'). It is not recommended to use the fully extended handle position when using as a carry or wheeling chair.
- Local manual handling protocols should be followed relative to moving of patient.
- Wherever possible ensure that the strongest/tallest person is at head-end when using the Chair as a carry chair for moving the patient on level ground.
- Inform the patient at all times so that they are aware about what is happening.
- The Chair will be tilted backwards to be rolled on its rear pair of wheels prior to movement. Ensure the patient is made aware of this.
- Holding the wheel with one foot as an anchor, the Chair should be tipped back until it reaches tipping point, and no more, and then maintain this balanced position before starting to set off.
- The foot-end operator should always aid the head-end operator when tipping the chair back, by holding onto the foot-end handles and lifting in conjunction and synchronisation with the head-end operator, thereby sharing and minimising the amount of effort operators need to exert.



Use your Foot to lock the wheel down and pull back to engage the wheels for an easier set off

8.5 Moving the Chair DOWN stairs using Powered Track Module

- It is recommended that the following procedures be practiced and trained with a chair loaded with a dummy or weights before any occupant is carried.
- Using the Chair on stairs requires a minimum of two operators. Use additional help, as needed.
- The two operators face each other when transporting a patient down stairs. If available, a third person should assist by acting as a guide for the foot-end operator.
- Ensure the route down the stairs is clear of obstructions that could affect the safety of the operators or the function of the track.

1. Before transferring the patient onto the chair, ensure Track is attached to Chair, refer to section 4.2 'Attaching Powered Track Module', that the motor power is switched on, that the control box is paired to the motor, that the speed setting is correctly set (recommended SLOW for non-emergency patient moves) and that the Motor brake setting is set to ON.

2. With the patient already transferred onto the chair away from the stairs, in line with local protocols and as per section 8.2, position the chair away from the stair edge but close enough so the foot-end operator can reach and grab the handles at the foot-end.

1. Foot-end operator - take up position on the stairs facing the chair, holding the lower foot-end handle.

2. Head-end operator – fully extend the upper handle and ensure it is locked in place (See section 'Adjusting Upper Handle Height').

3. Head-end operator – deploy the track for use and ensure it is locked in place (See 'Unfolding the Track ready for Use').

4. Both operators – working together, tip the chair back until the track can be felt to be touching the floor and the wheels are off the ground, tipping back sufficiently that the angle of the track is approximately in line with the stair angle (foot-end operator can visibly check angle of track, head-end operator can use the bannister as a visible guide how far back the chair needs to be tipped). Make sure not to tip the chair too far such that it goes past the required angle such that head-end operator is taking the weight of the patient and the angle of the track will be incorrect.

5. Head-end operator - communicating with foot-end operator at all times, start driving the chair towards the stair edge by pressing the green "-" button and continue to drive the chair over the top step edge and onto the stairs in one constant movement, ensuring that the track angle is about the same angle of the stairs, such that the chair is then transferred fully onto the stairs both smoothly and safely.

6. Both operators – continue to move the Chair over the edge and downwards until the track transfers to 2 steps, then three steps in a smooth and controlled manner, the foot-end helping to maintain the correct angle by lifting up or pushing down on the front handles.



Preparing to descend steps



Rolling Track onto steps



Bottom of steps

8.5 Taking the Chair DOWN stairs with the Powered Track attached (cont...)

7. Head-end operator - as soon as the chair transitions from the top step landing and fully onto the stairs, a constant downward pressure should be applied to the top handle to ensure that the rear of the track remains on the steps at all times, using their body weight to hold the track onto the stairs.

To maintain the glide angle coming down the stairs–

- Head-end operator – with a palm-down hand-grip maintain constant downward pressure on the extended upper handle to hold track onto the stairs and continue moving downwards by keeping the '-' button pressed and follow the chair moving down the stairs.
- Foot-end operator – holds the Chair into the stairs, adjusting/raising/lowering accordingly to maintain glide angle. Foot-end should not push down on the front handles as this will counteract the head-end holding the Chair into the stairs. The foot end should hold the chair into the stairs by applying a gentle forward pressure into the staircase, stepping down the stairs step by step as the chair descends the stairs.

The foot-end operator should communicate to the head-end operator when the Chair reaches near to the bottom of the stairs and wheels are near to the floor, and advise as the wheels touch the ground, and the head-end stop moving the chair by letting go of the '-' button. At this point the Chair should be tipped forward onto the ground and upper handle and track then stowed. The head-end operator can then tilt the chair backwards to wheel and manoeuvre the Chair onwards and away from the stairs, aided by the foot-end operator to tip the chair, if required.

- To pause during the descent at any time, the head-end operator, whilst maintaining downward pressure on the handle, simply stop pressing the '-' button, the foot-end also continue to hold the Chair into the stairs. The downward weight of the patient, the friction between stair edges and track belt and the motor brake which automatically engages when the '-' button is pressed ensures that the Chair stays stationary on the stairs with very little effort required by both operators to hold stationary on the stairs.

When ready to go again, the head-end simply presses the '-' button to start off again.



Rolling Track onto steps



Bottom of steps

8.6 Moving the Chair UP stairs using Powered Track Module

- Using the Chair to move upstairs requires a minimum of two operators. Use additional help, as needed.
- The two operators face each other when transporting a patient upstairs. If available, a third person should assist by acting as a guide for the foot-end operator.
- Ensure the route up the stairs is clear of obstructions that could affect the safety of the operators or the function of the track.

1. Before transferring the patient onto the chair, ensure Track is attached to Chair, that the motor power is switched on, that the control box is paired to the motor, that the speed setting is correctly set (recommended SLOW for non-emergency patient moves) and that the Motor Brake setting is set to ON.

2. With the patient already transferred onto the chair, position the chair away from the bottom stair edge but close enough such that when the chair is tipped fully backwards, the track will touch the bottom 2 steps.

1. Foot-end operator - take up position in front of the chair, knelt down on the ground and holding the lower foot-end handles.

2. Head-end operator – fully extend the upper handle and ensure it is locked in place.

3. Head-end operator – deploy the track for use and ensure it is locked in place.

4. Both operators – working together, tip the chair back until the track is resting on the bottom 2 steps.

4. Foot-end operator – hold the chair hard into the bottom stair edge such that when the track starts moving it gets sufficient grip not to slip.

5. Head-end operator - communicating with foot-end operator at all times, start moving the chair up the stairs by pressing the blue "-" button and continue to hold the chair down into the stairs such that the track maintains contact with each steps as the chair is moving up the stairs.

4. Foot-end operator – continue to hold the chair into the stairs, once the chair is on 3 steps and moving smoothly, continue to follow the chair up the stairs gently holding it into the stairs. Do not push down on the front handles as this will counteract what the head-end operator is doing.

5. Foot-end operator – once the Chair is nearing the top of the stairs, communicate to the head-end operator that they need to start tipping the chair upright such that the head-end operator has sufficient space on the top landing to bring the chair fully up and away from the last step and also to ensure the transfer from track to wheel is smooth.

6. Both operators – when the wheels are just below the last step, both operators start tipping the chair back upright, continuing to drive the chair up over the top step and way from the step such that there is space to tip fully upright and bring the chair back onto to the ground at the foot-end.

7. Once reached past the top step and back on the ground, Head operator should stow the track and lower the upper handle and then wheel the patient away from the stairs.



At bottom of steps

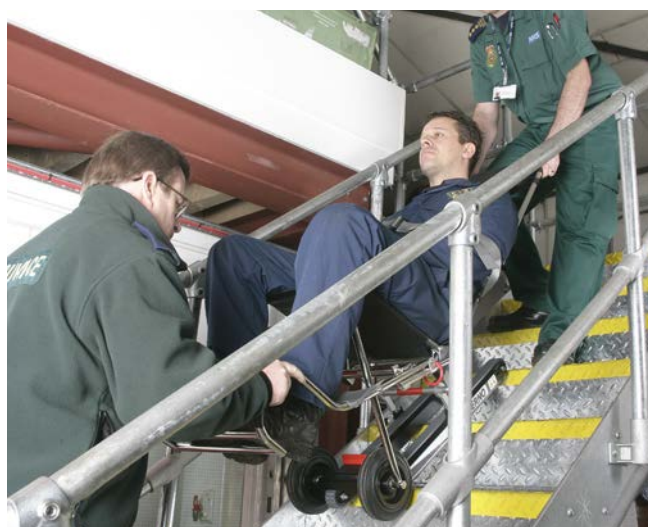

Moving the Chair up stairs



Driving the chair up and past the top step

8.7 Using the Chair Powered Track Module to navigate around narrow landings

Where there is sufficient space and the situation has been risk assessed, the Powered Track module can be used to aid navigating around a 90 landing between 2 flights of stairs, and also in other situations.

Instead of stopping when reaching the bottom of the first flight of steps, then tipping the chair upwards to put the chair down onto the ground, closing off the track and then manually manoeuvring the chair around the 90 degree landing corner on the chair wheels, instead, once the chair has reached the bottom of the first flight of steps and the wheel and track are touching the landing floor, the head-end operator can continue to drive the chair under power around the 90 degree landing by keeping the '-' button pressed, the foot-end operator holding the foot-end handles to aid driving around the landing and also to help maintain stability, then making sure the chair is in directly in line with the second flight of stairs and not at an angle, before continuing down the next flight of steps.

On a very narrow or tight set of stairs it will not be possible to use the powered track to manoeuvre around the 90 degree landing in one movement as there will be insufficient space to do so, but the powered track can still be used to assist manoeuvring chair around the corner as and when required.

8.8 Chair Positioning on the stairway

Positioning on the stairway is also important when manoeuvring around stairways.

In most scenarios, the Chair should be positioned in the middle of the stairway before starting to move up/down the stairs. However, for narrow stairways with a tight landing in between the first and second flight of steps, it is better to position the chair more towards the right or left of the stairway to give more turning area on the landing, but not too close as to create a potential hazard of catching against the staircase wall or bannister.

When going down stairs with a left-hand landing turn to the second flight of steps, position the chair nearer to the right hand side of the staircase thereby giving a better turning area on the landing, and to the left of the stairway for a right-hand turn landing. Similarly for going upstairs, position the chair to the left of the stairs of staircase with a right hand turn to the second flight of steps, and to the right of the stair with a left hand landing turn.

8.9 Using the Powered Track Module to give more space around narrow landings

In very tight stairway landings, the powered track can also be used to give more space when manoeuvring around the landing. When coming down the first flight of steps, the chair should be stopped as soon as the wheels touch the first landing. At this point due to the angle of the stairs, the wheels will be some distance from the bottom step. With the track still deployed, the head-end operator can move the chair back against the bottom step by tipping the chair upwards, but still on the track, whilst pressing the '+' button, thereby then giving more space to manoeuvre around the landing to go down the second flight of steps.



Stop as soon as wheels touch the landing floor



Tip the chair upwards whilst using the "+" button to bring the chair nearer to the bottom step, to then give more room to manoeuvre around the landing

8.10 Carrying the Chair DOWN stairs WITHOUT using the Powered Track Module

The Chair can be used as a Carry Chair to move a patient downstairs where the circumstances do not allow the use of the track system, for example around a full spiral staircase, and a suitable dynamic risk assessment has been undertaken.

This manoeuvre should be carried out with the Track Module detached from the Chair, and all manual handling procedures and risk assessment should be considered before carrying out such a manoeuvre.

1. With the patient seated on the Chair and restrained, adjust the upper handle into a position that is comfortable for your height according to the stairs being used, but as low as possible to maximise stability and minimise any risk of the chair tipping sideways when lifting and moving the occupant (See 'Adjusting Upper Handle Height').

2. Always inform the patient about what is happening.

3. Once the head-end and foot-end operators are in their correct positions holding the upper and lower handles, the Chair should be tipped backwards until the occupants weight is on the wheels.

4. The Chair can then be rolled towards the top of the stairs and then lifted by both operators to begin descending the stairs.

5. Upon reaching the bottom of the stairs, carefully lower the wheels onto the floor and continue to move the patient to the required destination by wheeling the Chair.

The Powered Track Module should be used wherever possible to minimise the need to lift and thereby minimise the effort required and manual handling risk when moving a patient.

8.11 Moving the Chair UP stairs WITHOUT using the Powered Track Module

The Chair can be used as a Carry Chair to move a patient up stairs where the circumstances do not allow the use of the track system and a suitable dynamic risk assessment has been undertaken. This manoeuvre should be carried out with the Track Module detached from the Chair, and all manual handling procedures and risk assessment should be considered before carrying out such a manoeuvre.

1. With the patient seated on the Chair and restrained, adjust the upper handle into a position that is comfortable for your height according to the stairs being used, but as low as possible to maximise stability and minimise any risk of the chair tipping sideways when lifting and moving the occupant (See 'Adjusting Upper Handle Height').

2. Always inform the patient about what is happening.

3. Once the head-end and foot-end operators are in their correct positions holding the upper and lower handles, the Chair should be tipped backwards until the occupants weight is on the wheels

4. The Chair can then be rolled towards the foot of the stairs and lifted by both operators to begin ascending the stairs

6. Upon reaching the top of the stairs, carefully lower the wheels onto the floor and continue to move the patient to the required destination by wheeling the Chair.

8.12 - In-Vehicle Storage Bracket

Available from Ferno is a 2-part storage bracket for safely storing the Compact PowerTraxx chair and Track module in vehicle, designed to be attached to a side wall or on the bulkhead of a vehicle with suitable support built into the wall. The bracket has been crash tested, CEN compliant to EN 1789. The track module and chair frame are stored separately on the bracket, the track attached to the bracket first, the chair frame attached after. Bracket part number 009103900.

To attach the Track module onto the storage bracket, first remove the battery from the Track and place on the in-vehicle charger to charge. Orientate the Track module with the motor facing you and towards the floor, then bring the track module toward the bracket at an approximate 45° angle, introducing the bottom of the track behind the rear of the cross bar on the bottom bracket and down towards the floor such that the axle locking mechanism on the track is in line with bracket the cross-bar, then push the top of the track forward towards the wall and the bottom of the track will then lock into place on the bottom cross-bar. Then use the small strap to hold the top of the track in place.

To attach the Chair, first orientate the Chair with the back of the chair facing you. Wheel the Chair towards the bracket and then with a slight lift, position the wheel axle into the slots on the bottom bracket, then push the chair forward towards the wall, allowing the upper bracket mechanism to ride over and past the chair footbar cross-bar, then use the storage bracket cross-strap to then secure the Chair in place.

To remove the Chair from the bracket release the cross-strap, angle the Chair towards you and lift out of the slots.

To remove the Track module, undo the top strap that holds the Track in place, angle the track back towards you and whilst lifting the red release lever at the bottom of the track, move the track slightly forward at the bottom and lift up to disengage from the cross-bar, then lift the track out and away from the bracket.



2-part bracket



Track attached



Track & chair attached



Side view



Cross-strap holding chair in place



Removal of Chair from slots in lower bracket



Unlocking of Track from cross-bar on lower bracket



Push forward and lift up to remove Track

9 - MAINTENANCE

9.1 Maintenance Schedule

The Chair requires regular inspection. Set up and follow a maintenance schedule. The table to the right represents minimum intervals for maintenance. Ferno recommend to lubricate every 3 months and/or after a deep clean.

Keep maintenance records.

When using maintenance products, follow the manufacturers' directions and read the manufacturers' material safety data sheets.

Alternatively the Chair can be inspected in line with the Ambulance maintenance schedule.

Further details on maintenance are available from Ferno (UK) Ltd. Service Division or through approved service technicians.

9.2 Cleaning & Disinfecting the Patient Straps

It is recommended to remove chest straps from the Chair before cleaning and disinfecting to ensure they can be cleaned effectively on all surfaces. The foot-strap needs to be cleaned in-situ as is not removable.

Cleaning Biosafe straps

1. Wipe-clean the strap, buckles and fixing clips with mild soap and water
2. Hang the strap to air-dry. Attach only clean, dry straps back onto to the equipment

Disinfecting Biosafe straps

1. Spray the straps, buckles and fixation clips with disinfectant cleaner spray, following the disinfectant manufacturer's instructions for application method and contact time
2. Hang the straps to air-dry if needed. Attach only dried straps to the equipment

9.3 Cleaning & Disinfecting the Chair & Track Module

Wipe all surfaces with disinfectant. Follow the disinfectant manufacturer's instructions for application method and contact time. Ferno recommend you inspect the Chair for damage as you clean and disinfect it.

1. Remove Track Module and any accessories.
2. Remove the Battery from the Track Module.
3. Hand clean all surfaces of the Chair and the Track Module with warm water and a mild detergent, avoiding the battery holder connectors.
4. Rinse with warm, clear water, avoiding the battery holder connectors.
5. Dry the Chair with a towel and allow it to air-dry thoroughly prior to storage.
6. To disinfect: Apply disinfectant to the Chair, following the disinfectant manufacturer's instructions for application method and contact time.
7. Do NOT spray or pressure wash the Powered Track Module.



WARNING

Improper maintenance can cause injury. Maintain the Chair only as described in this manual.

Recommended Maintenance Intervals	Each Use	As Needed	3 Months
Disinfecting	•		
Cleaning		•	
Inspecting	•	•	•
Lubricating			•

IMPORTANT

Disinfectants and cleaners containing phenol or iodine can cause damage, it is recommended not to use products containing these chemicals.

If using disinfectant that is chlorine-based then ensure the concentration used is no higher than 10,000 ppm.

If higher than 10,000 ppm, it is recommended to use for the manufacturer's minimum recommended effective contact time after which any residue should be wiped off.

Accessories such as push poles, IV poles etc. should be cleaned and disinfected whilst detached from the trolley and the fixing points on the trolley also cleaned and disinfected.



WARNING

Modifying the Chair can cause injury and damage. Use the Chair only as designed by Ferno.

9.4 Control unit batteries

The chair is fitted with a control unit powered by two "AA" type batteries. If the controls do not respond and the display does not turn on, replace the batteries.

If the "low charge" indicator light (⚡) switches on, the batteries must be replaced. Access to the batteries is achieved by opening the compartment below the control unit.

TO REPLACE THE TWO AA BATTERIES:

- Use a cross head screwdriver to undo the battery compartment screws. Lift the battery compartment cover.
- Remove the batteries, see figure.
- Remove the batteries from their compartment and replace them, taking care to re-fit the rubber seal correctly.
- Repeat the steps in reverse order.



Opening the battery compartment



Battery compartment



Changing the batteries

9.5 Auxiliary connection cable

The chair is supplied as standard with an auxiliary cable.

The auxiliary cable allows to re-establish the wireless connection (re-pair) between the control unit and the motor, if connection is lost. It also allows the control box to be temporarily powered by the motor battery if the control box batteries have fully depleted and no spare batteries immediately available.

If the connection is lost or need to use power from the main motor battery, perform the following re-connection procedures:

1. Open the control unit connector compartment with the aid of a coin.
2. Insert the auxiliary cable connector into the port located in the compartment.
3. Remove the door protection on the motor housing.
4. Connect the cable's serial plug to the port on the motor housing.
5. Press the power button of the chair and wait for the wireless interface and the motor to be synchronized. A double beep will confirm that connection has been successfully completed.
6. Once completed (or batteries have been replaced in the control box and has been re-paired) disconnect the cable from the controller by removing the cable from the connection ports and ensure to put the covers back on both the control box and the motor.



Opening the connector compartment

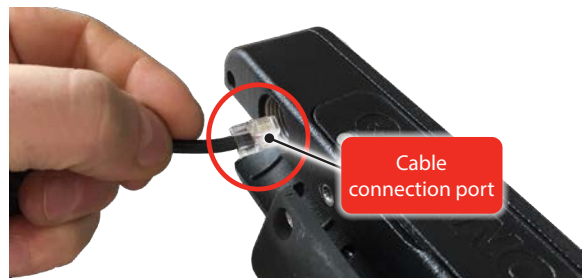

Connecting the cable to the connector port



Port on the motor housing



Connecting the cable to the motor housing



Unplugging the connector

9.6 Inspecting the Chair Frame

Have your service's equipment maintenance technicians inspect the Chair regularly. Follow the checklist below and operate the Chair through all its functions as described in this manual.

If inspection shows damage or excessive wear, remove the Chair from service until repair is made. See *Parts and Service*, page 21.

IMPORTANT

Water under high pressure, or steam, can penetrate joints, flush away lubricant, and cause corrosion. Use caution when cleaning moving parts such as joints and hinges, and reapply lubricant if needed (see right). Do not spray clean the Track Module.

IMPORTANT

Using abrasive cleaning compounds or applicators on the Chair can cause damage. Do not use abrasive materials to clean the Chair.

INSPECTION CHECKLIST

- Are all components present?
- Is the Chair and Track free of excessive wear?
- Are all screws, nuts, bolts, rivets, and roll pins securely in place?
- Do all moving parts operate smoothly and properly?
- Does the Chair rear handle lock properly into each position?
- Does the safety hook engage the safety bar?
- Does the Chair roll smoothly?
- Do the wheels have adequate tread?
- Are the restraints properly installed?
- Is restraint webbing in good condition with no cuts or frayed edges?
- Are restraint buckles free of visible damage and do they operate properly?
- Does the Track module deploy properly and lock into place?
- Does the Track module stow properly and lock into place? Make sure the track module is not loose and does not easily drop back down

IMPORTANT

Lubricating parts that should not be lubricated allows dirt and foreign particles to collect on those parts, resulting in damage.

9.7 Lubricating the Chair Frame

Disinfect and clean the Chair before applying lubricant. Use the lubricants designated below to lubricate the Chair. Do not lubricate points marked with the "do not lubricate" symbol.



Do Not Lubricate



Lubricate

LUBRICATION POINTS

Use a small amount of lubricant, lubricating identical points on each side of the Chair, using a liquid lubricant oil such as "3-IN-ONE Multi-purpose drip oil"

1. Push-to-close Latches
2. Locking Bar
3. Hinge Points

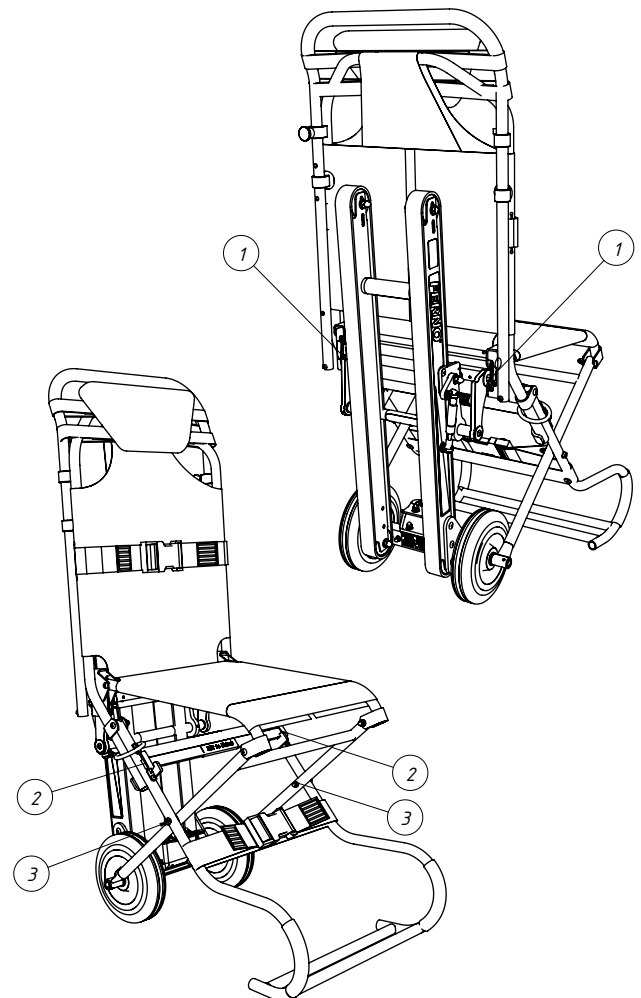

WARNING

Do NOT lubricate the track belts. Doing so will result in a loss of friction, causing danger to the operator and occupant when descending stairs.

10 - PARTS AND SERVICE

10.1 UK Support

In the United Kingdom, to order parts or for professional Chair repair, contact Ferno (UK) Ltd. - the only agent authorised by Ferno to manage, service, and repair Ferno products.

Telephone Main Reception	+44 (0)1274 851999
Service Department	+44 (0)1274 854511
Service Email	services.uk@ferno.com
Web	www.ferno.com/uk

10.2 Worldwide

To order Ferno parts, and for professional Chair repair, contact your Ferno distributor. Your distributor is the only agent authorised by Ferno to manage, service, and repair Ferno products.

WARNING

Improper parts and service can cause injury. Use only Ferno parts and Ferno-approved service on the Chair.

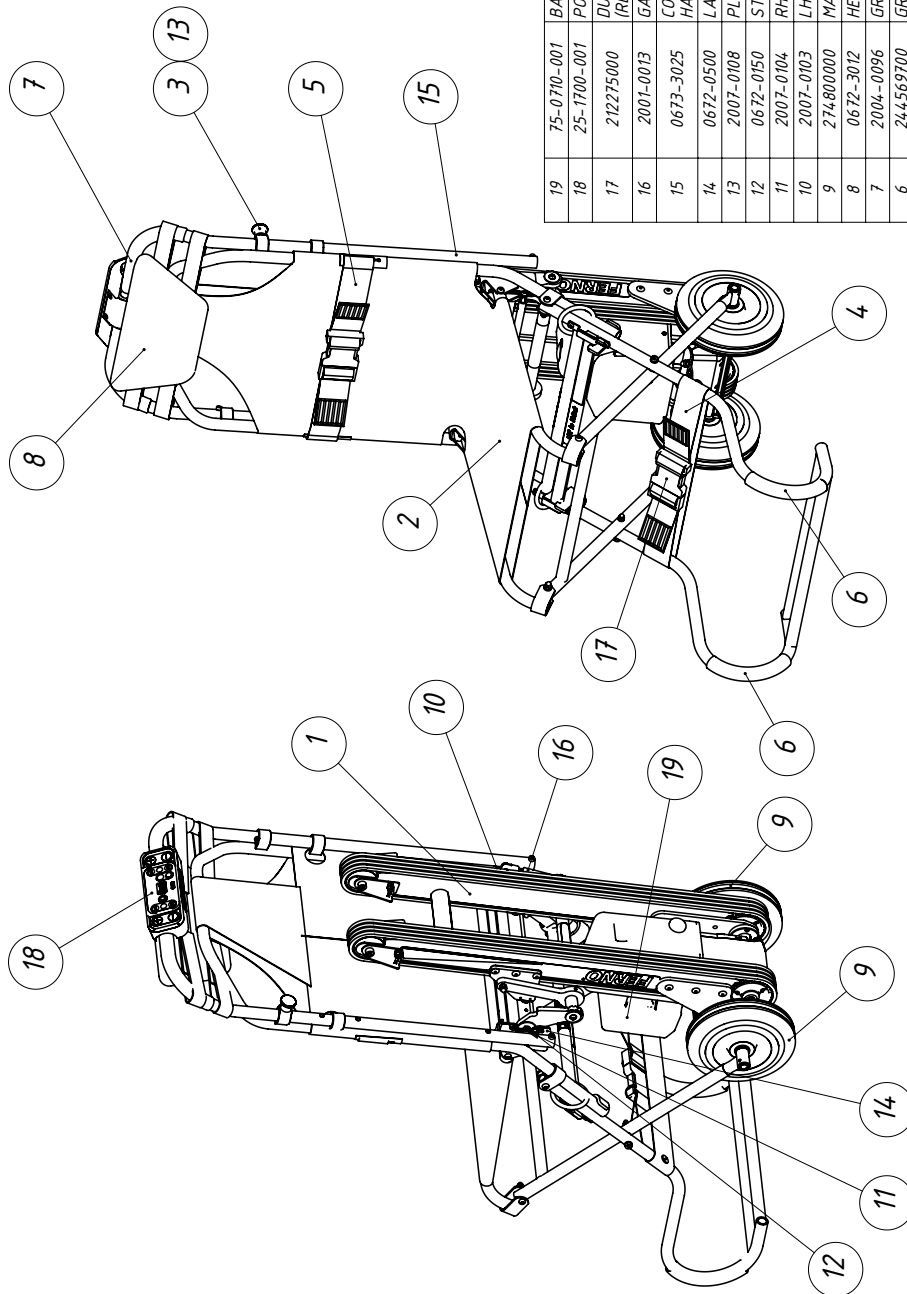

ITEM #	UK PART #	DESCRIPTION
19	75-0710-001	BATTERY
18	25-1700-001	POWERTRAXX CONTROL BOX
17	212275000	DUAL ADJUST BUCKLE 50 mm (REPLACEMENT)
16	2001-0013	GAS SPRING 300 N EZ GLIDE TRACK
15	0673-3025	COMPACT POWERTRAXX EXTENDABLE HANDLE C/W GRIP TAPE
14	0672-0500	LATCH COVER
13	2007-0108	PLUNGER SPACER
12	0672-0150	STRIKER LOCKING BOLT
11	2007-0104	RH PUSH TO CLOSE LATCH
10	2007-0103	LH PUSH TO CLOSE LATCH
9	274800000	MAIN WHEEL
8	0672-3072	HEADPAD
7	2004-0096	GRIP TAPE 2M LONG
6	244569700	GRIP TAPE 1M LONG
5	0672-3007	COMPACT 2 TRACK CHEST RESTRAINT
4	0672-3008	COMPACT 2 TRACK LEG RESTRAINT
3	2007-0120	RED INDEX PLUNGER
2	0673-150	COMPACT POWERTRAXX SEAT COVER
1	25-00105	NARROW TRAXX

